

## NKX25-Z-XL

Needle roller/axial ball bearing

Schaeffler ID:  
0507475840000

Needle roller/axial ball bearings NKX...-Z, axial component, single direction, to DIN 5429, with end cap, for grease lubrication

X-life

### Technical information

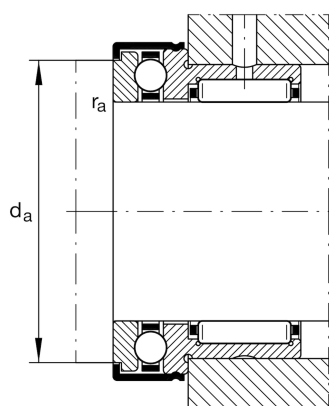
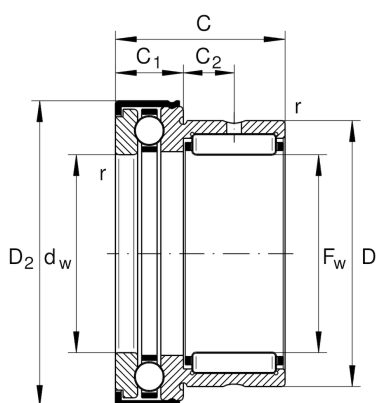

### Main Dimensions & Performance Data

$F_w$	25 mm	Bore diameter
$D$	37 mm	Outside diameter
$C$	30 mm	Height
$C_r$	21,300 N	Basic dynamic load rating, radial
$C_{0r}$	30,500 N	Basic static load rating, radial
$C_a$	19,600 N	Basic dynamic load rating, axial
$C_{0a}$	37,500 N	Basic static load rating, axial
$C_{ur}$	5,400 N	Fatigue load limit, radial
$C_{ua}$	1,840 N	Fatigue load limit, axial
$n_G$	6,000 1/min	Limiting speed
	129.13 g	Weight

### Dimensions

$D_{1\max}$	43.2 mm	Maximum outside diameter flange
	IR20X25X20-XL	Suitable inner rings IR
$D_{2\max}$	43.2 mm	Maximum outside diameter flange
$C_1$	11 mm	Width of the axial bearing component
$C_1$	9.5 mm	Distance to lubrication hole
$C_2$	9.5 mm	Distance to lubrication hole
$d_w$	25 mm	Bore diameter of shaft washer
$r_{\min}$	0.6 mm	Minimum chamfer dimension

### Mounting dimensions

$d_a$	37.7 mm	Mounting dimension shaft shoulder
$r_{a\max}$	0.6 mm	Maximum recess radius

### Temperature range

$T_{\min}$	-30 °C	Operating temperature min.
$T_{\max}$	120 °C	Operating temperature max.